

Stand-alone type Infrared Gas Analyzer

4-component analyzer

Type: ZRJ Standard type



Simultaneous and continuous measurement of gas concentration of up to 4 components out of NO_x, SO₂, CO, CO₂, CH₄, and O₂

● Ideal for combustion control of various industrial furnaces

NO	: 0 to 500ppm	5000ppm
SO ₂	: 0 to 500ppm	5000ppm
CO	: 0 to 200ppm	100%
CO ₂	: 0 to 500ppm	100%
CH ₄	: 0 to 1000ppm	100%
O ₂	: 0 to 5%	25%

5-component analyzer

Type: ZKJ High performance type



Simultaneous and continuous measurement of gas concentration of up to 5 components out of NO_x, SO₂, CO, CO₂, CH₄, N₂O, and O₂

● Ideal for measurement of low-concentration components

NO	: 0 to 50ppm	5000ppm
SO ₂	: 0 to 50ppm	10%
CO	: 0 to 50ppm	100%
CO ₂	: 0 to 20ppm	100%
CH ₄	: 0 to 200ppm	100%
N ₂ O	: 0 to 200ppm	2000ppm
O ₂	: 0 to 5%	25%

• Arbitrary range setting is allowed within specified range.

● Simple operation allowed by easy-to-see large LCD

3-component display



Menu screen

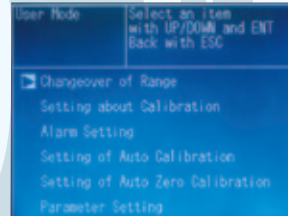

5-component display



Alarm setting screen

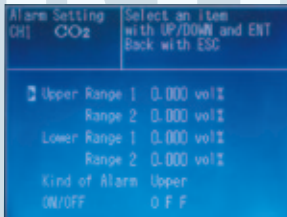

Range select screen

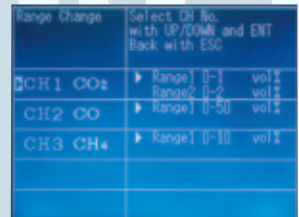

4

-component analyzer

Type: ZRJ
single-beam



Principle The amount of infrared ray absorbed in the measurement cell is detected with a mass flow sensor.

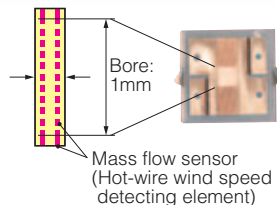
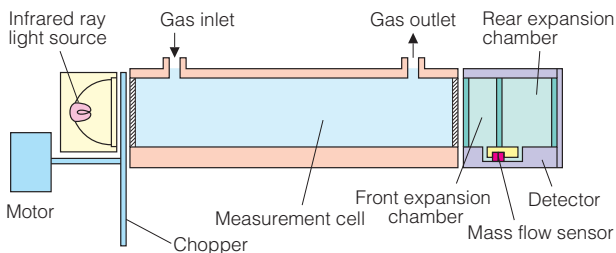

<Mass flow sensor>

The low impedance sensor has high noise immunity. The sensor with no movable parts has high resistance to vibration, and thus can be used semipermanently. Infrared ray absorption by measured gas component is converted into electric signals.

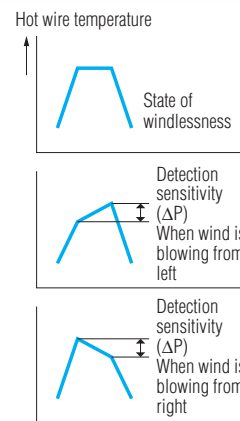

Example of gas sampling system configuration

(For measurement of ambient gas of heat treat furnace)

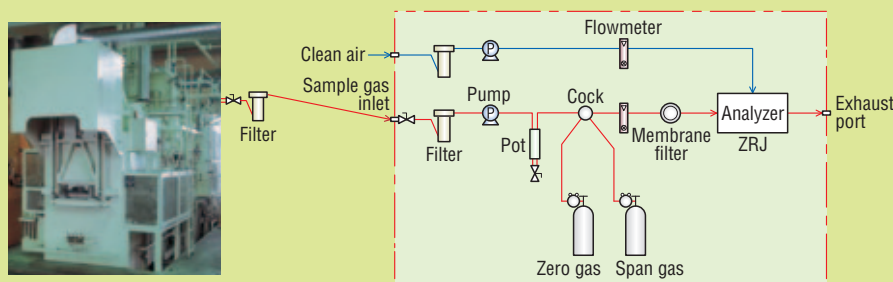

Zirconia type O₂ Sensor

Type : ZFK7



General Specifications

Measurement principle	NO _x , SO ₂ , CO, CO ₂ , CH ₄ : Non-dispersive infrared ray system (single-beam) O ₂ : Paramagnetic type (built in), galvanic cell type (built in), or zirconia type (Type ZFK7, Separately installed)
Measured component	NO: 0 to 500ppm..... 5000ppm SO ₂ : 0 to 500ppm..... 5000ppm CO: 0 to 200ppm..... 100% CO ₂ : 0 to 500ppm..... 100% CH ₄ : 0 to 1000ppm..... 100% O ₂ : 0 to 5%25% (2-range switching, Maximum range ratio 1:5, O ₂ excluded)
Repeatability	±0.5%FS
Linearity	±0.1%FS or lower
Zero drift	±2.0%FS or lower/week
Span drift	±2.0%FS or lower/week
Gas extraction volume	1L/min. ±0.5L/min.
Response time	90% response from gas inlet: 15 sec. or shorter (2-component measurement)
Output signal	4 to 20mA DC or 0 to 1V DC (Max. non-insulated output point: 8) Instantaneous output value (measured gas concentration of each component) Instantaneous output value after O ₂ correction, Average output value after O ₂ correction, Average O ₂ output Permissible load resistance: 550Ω or lower (4 to 20mA DC), 100kΩ (0 to 1V DC)

External contact input	No voltage contact Auto calibration start, Average value reset, Range selection, Output hold
Contact output	Range identification of each component, Instrument error, Calibration error, Auto calibration in progress, CO peak count alarm, Instantaneous value concentration alarm for each component, Pump ON/OFF
Communication function	RS-232C (MODBUS) option
Auto calibration function	Auto zero and span calibration (Calibration cycle settable)
Display	LCD with backlight Instantaneous value of each component, Instantaneous value after O ₂ correction, Average value after O ₂ correction, Average O ₂ value, CO peak count Parameter setting display (English or Japanese can be selected.)
Outside dimension, weight	177 (H) × 483 (W) × 493 (D) mm, About 10kg
Power supply voltage	100 to 240V AC, 50/60Hz, 70VA

Standard measured gas conditions for gas analyzer

Temperature	0 to 50°C
Pressure	10kPa or lower (The gas outlet should be at atmospheric pressure.)
Dust	100μg/Nm ³ or lower with particle size of 1μm or lower
Mist	No mist allowed.
Moisture	Saturated at 2°C (No condensation allowed.)
Corrosive component	1ppm or lower

5-component analyzer

Type: ZKJ

double-beam



Principle The amount of infrared ray absorbed in the measurement cell is detected with a mass flow sensor.

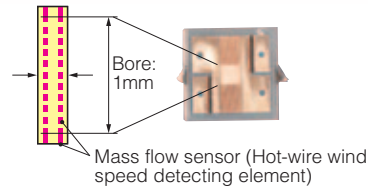
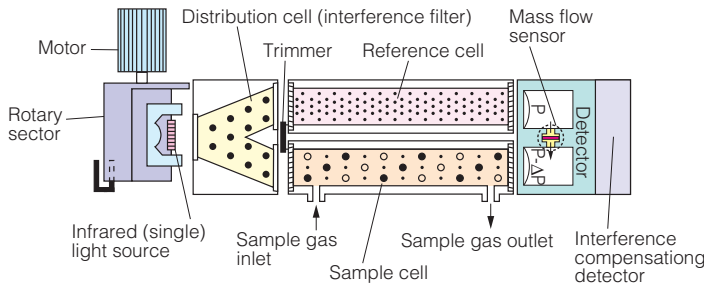

<Mass flow sensor>

The low impedance sensor has high noise immunity. The sensor with no movable parts has high resistance to vibration, and thus can be used semipermanently. Infrared ray absorption by measured gas component is converted into electric signals. Maximum range ratio of 1:25 is allowed with the high sensitivity analyzer.

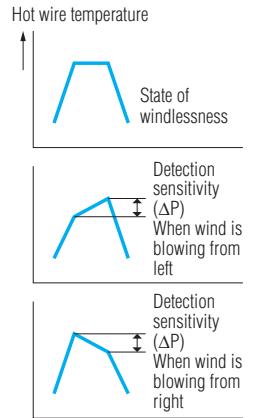

Example of gas sampling system configuration

(For measurement of exhaust gas from boilers and refuse incinerators)

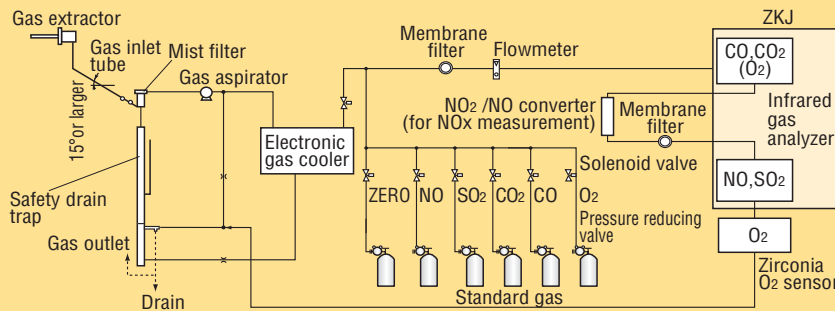

Zirconia type O₂ Sensor

Type : ZFK7



General Specifications

Measurement principle	NO _x , SO ₂ , CO, CO ₂ , CH ₄ : Non-dispersive infrared ray system (Double-beam) O ₂ : Paramagnetic type (built in) or zirconia type (Type ZFK7, Separately installed)
Measured component	NO: 0 to 50ppm 5000ppm SO ₂ : 0 to 50ppm 10% CO: 0 to 50ppm 100% CO ₂ : 0 to 20ppm 100% CH ₄ : 0 to 200ppm 100% N ₂ O: 0 to 200ppm 2000ppm O ₂ : 0 to 5% 25% (2-range switching, Maximum range ratio 1:5, O ₂ excluded)
Repeatability	±0.5%FS (±1%FS for concentration of less than 50ppm)
Linearity	±1.0%FS or lower
Zero drift	±1.0%FS or lower/week (±2.0%FS/week for concentration from 50ppm to 200ppm)
Span drift	±2.0%FS or lower/week (±2.0%FS/day for concentration of less than 50ppm)
Gas extraction volume	0.5L/min. ±0.2L/min.
Response time	90% response from gas inlet: 60 sec. or shorter
Output signal	4 to 20mA DC or 0 to 1V DC (Max. non-insulated output point: 12) Instantaneous output value (measured gas concentration of each component) Instantaneous output value after O ₂ correction, Average output value after O ₂ correction, Average O ₂ output Permissible load resistance: 550Ω or lower (4 to 20mA DC), 100kΩ (0 to 1V DC)

External contact input	No voltage contact Auto calibration start, Average value reset, Range selection, Output hold, Pump ON/OFF
Contact output	Range identification of each component, Instrument error, Calibration error, Auto calibration in progress, Pump ON/OFF, CO peak count alarm, Instantaneous value concentration alarm for each component, Power OFF
Communication function	RS-232C (MODBUS) option
Auto calibration function	Auto zero and span calibration (Calibration cycle settable)
Display	LCD with backlight Instantaneous value of each component, Instantaneous value after O ₂ correction, Average value after O ₂ correction, Average O ₂ value, CO peak count Parameter setting display (English or Japanese can be selected.)
Outside dimension, weight	177 (H) × 483 (W) × 578 (D) mm, About 22kg
Power supply voltage	100 to 240V AC, 50/60Hz, 250VA

Standard measured gas conditions for gas analyzer

Temperature	0 to 50°C
Pressure	10kPa or lower (The gas outlet should be at atmospheric pressure.)
Dust	100μg/Nm ³ or lower with particle size of 1μm or lower
Mist	No mist allowed.
Moisture	Saturated at 2°C (No condensation allowed.)
Corrosive component	1ppm or lower

Outline Diagram (Unit mm)

Type : ZRJ

<Upper>

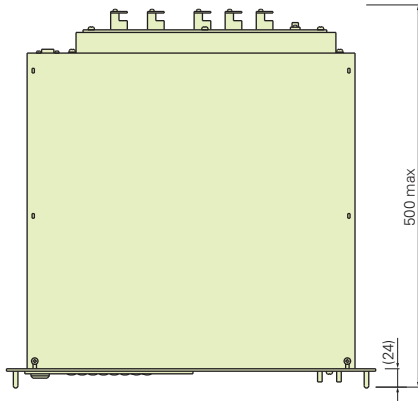

<Side>

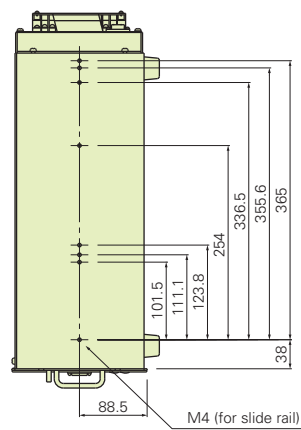

<Front>

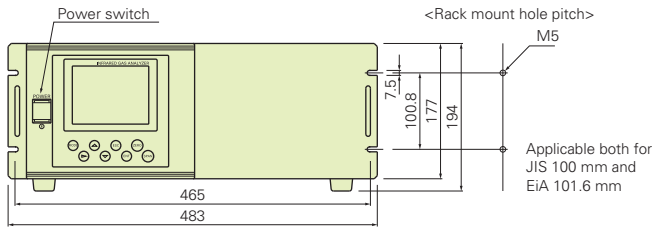

<Rear>

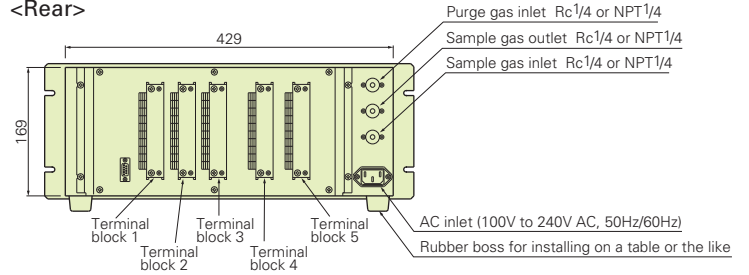

Type : ZKJ

<Upper>

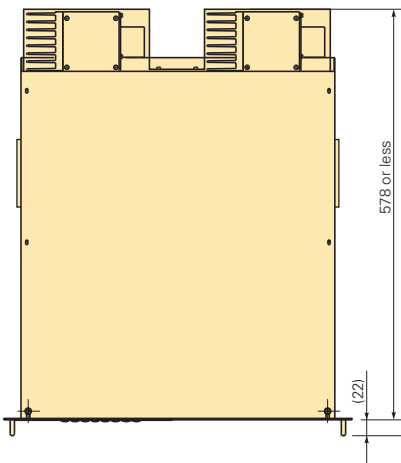

<Side>

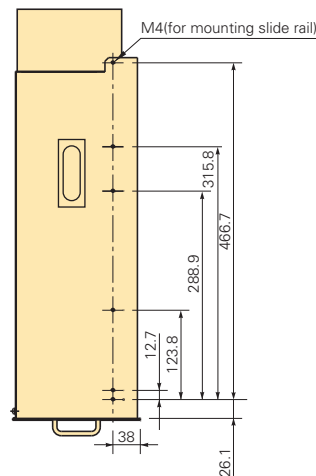

<Front>

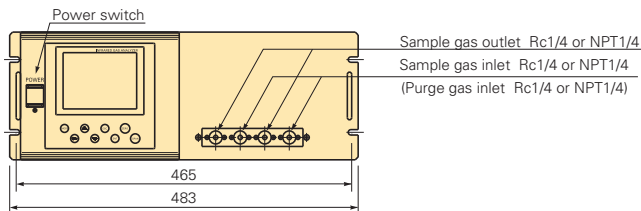

<Rear>

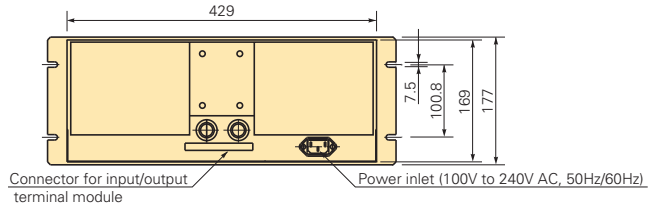

Fuji Electric Co., Ltd.

International Sales Div.

Sales Group

Gate City Ohsaki, East Tower, 11-2, Osaki 1-chome,
Shinagawa-ku, Tokyo 141-0032, Japan

<http://www.fujielectric.com>

Phone: 81-3-5435-7280, 7281 Fax: 81-3-5435-7425

<http://www.fujielectric.com/products/instruments/>